



**TOPTRONIC**  
LE DIALOGUE ELECTRONIQUE  
BIEN AJUSTE

# NOTICE TECHNIQUE

## NEUROKOM® IP

### platine KI 917-U



Jumper :  
led de fonctionnement  
active sur face avant

USB 5 V DC/1A

Interface série

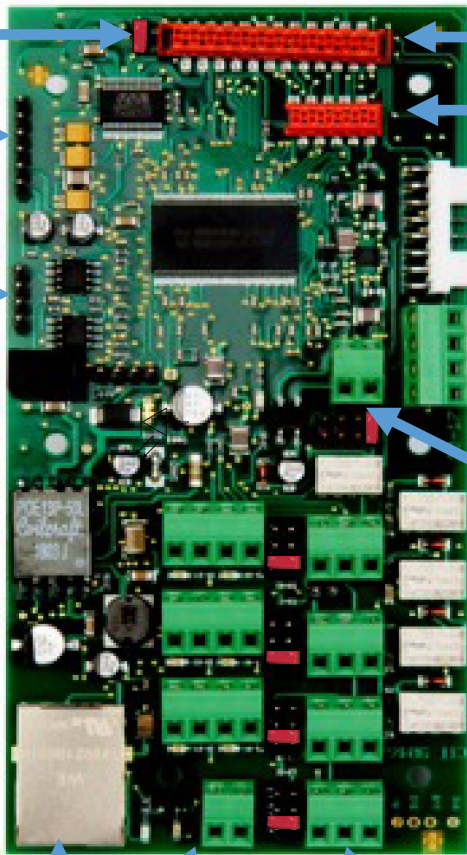

Connexion 24 pin vers display et clavier /M/L/Led

Connexion 908-EV

Branchement combiné

Connexion micro et HP

Entrée E1 paramétrable en 4 tensions AC/DC  
5 V/12 V/24 V / 48 V

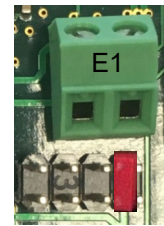
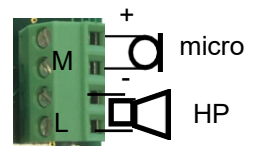

Jumper

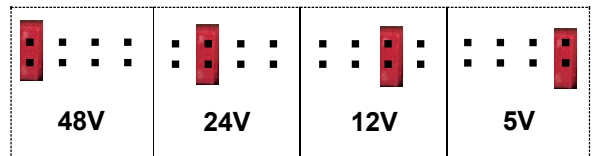

LAN

6 entrées OV  
contacts libres de potentiel

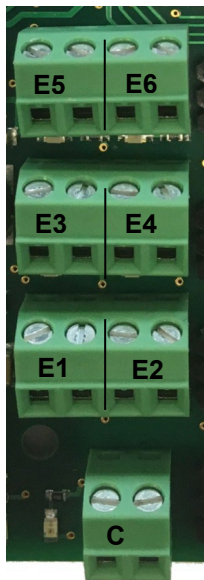

Touche C

4 sorties relais capacité de coupure 2A/30 V ou connexion led  
jumper relais jumper led

R4

R3

R2

R1

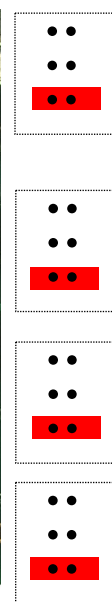
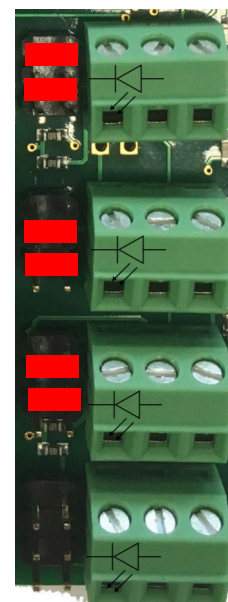
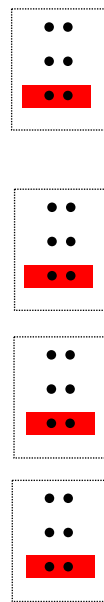
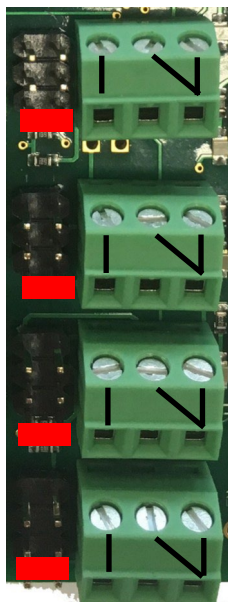

# Platine KI 917-U - Leds et encombrements

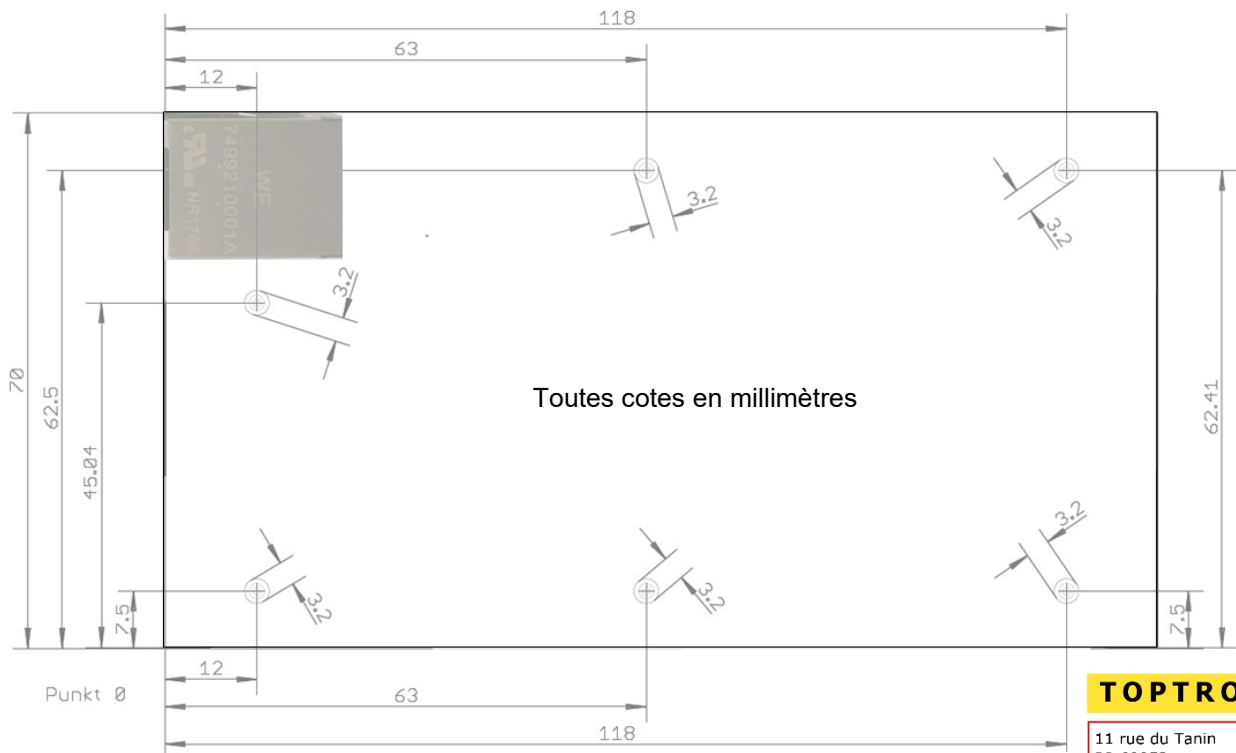
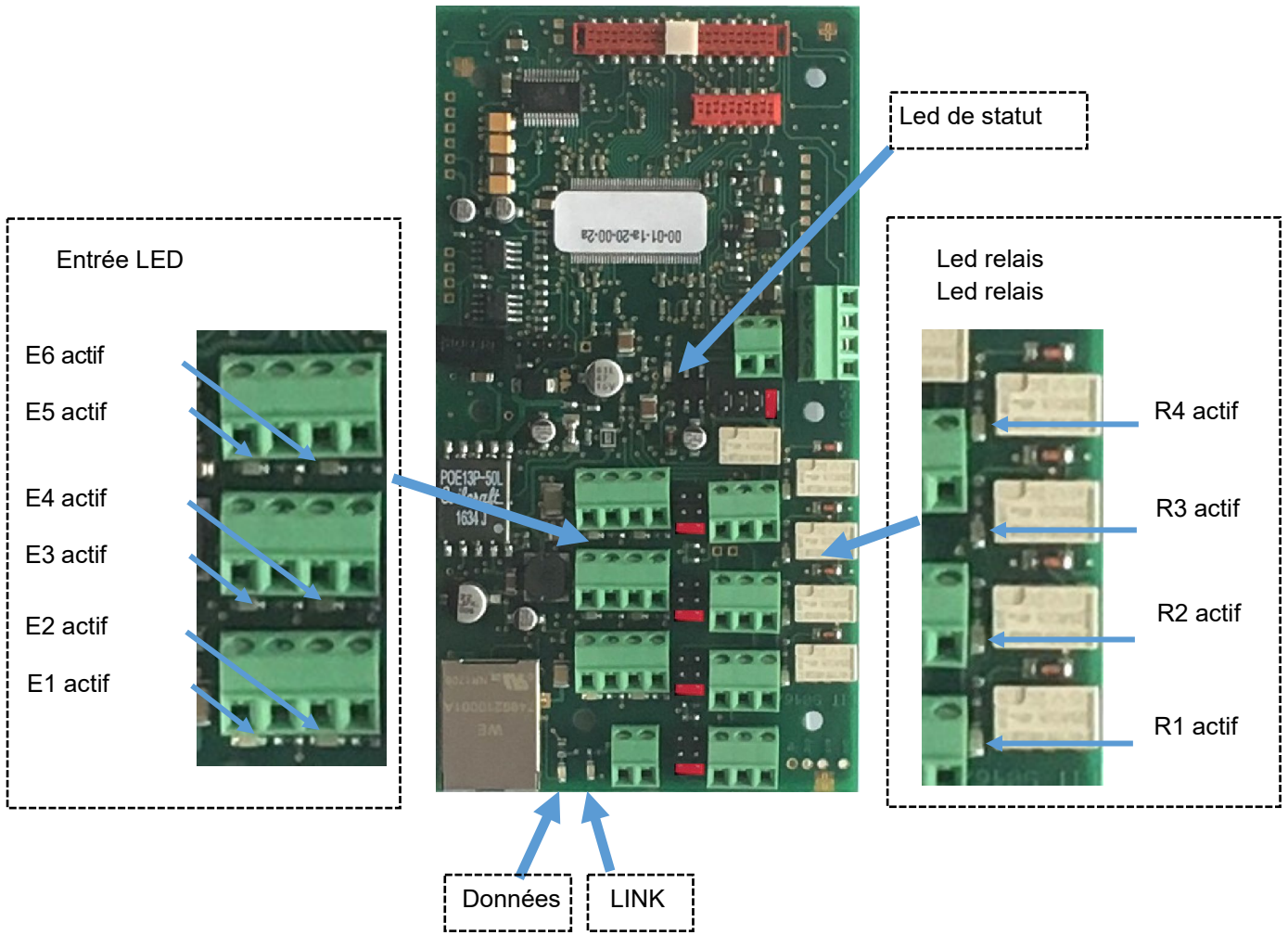

**TOPTRONIC**

11 rue du Tanin  
 BP 60052  
 67382 LINGOLSHEIM CEDEX  
 Tél : 03 88 77 49 75  
 Fax : 03 88 77 49 77  
 e-mail : contact@toptronic.fr  
<http://www.toptronic.fr>

